

AN EDUCATIONAL
ACTIVITY BOOKLET



Meridian.

The Power of Wind

GET BLOWN AWAY LEARNING ABOUT WIND!

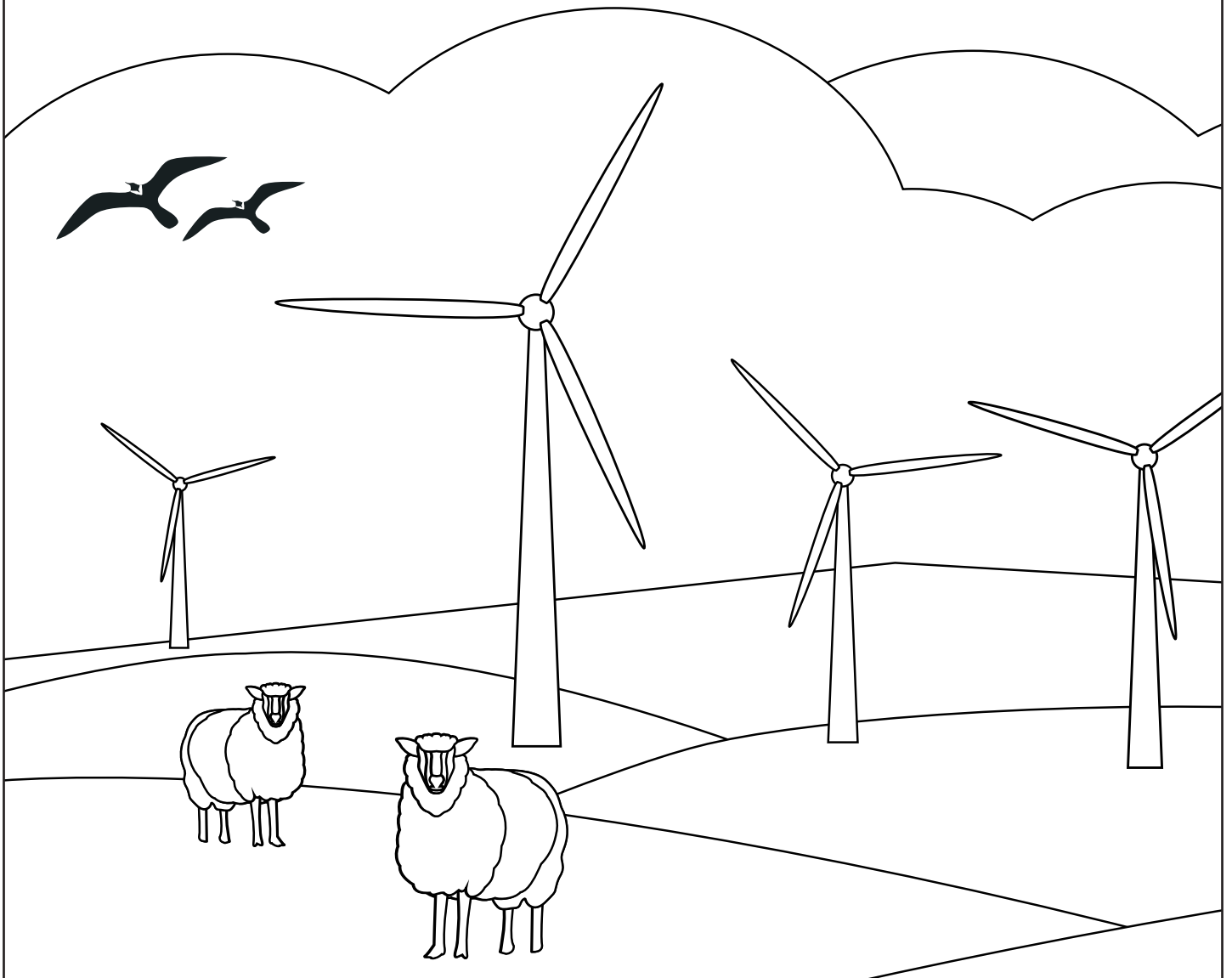

The Power of Wind

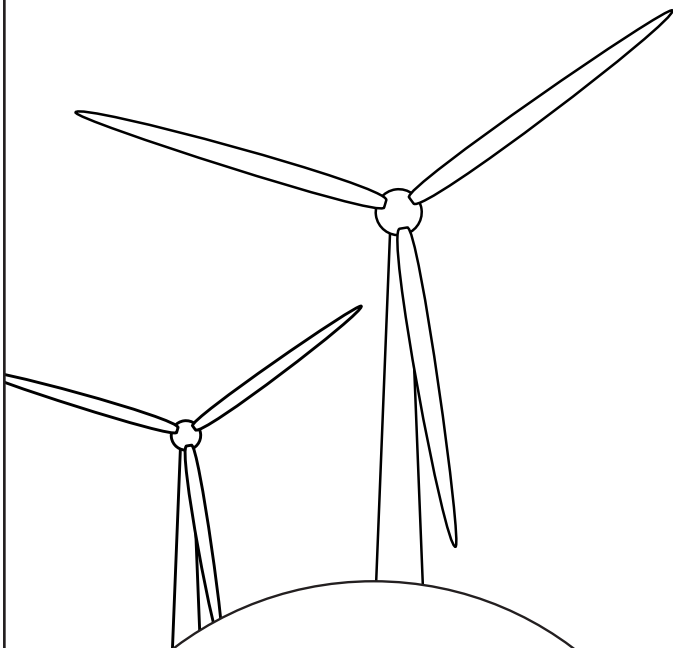
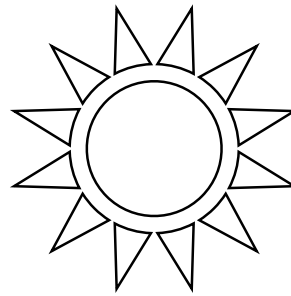

How wind forms

Warm air rises, cooler air moves in

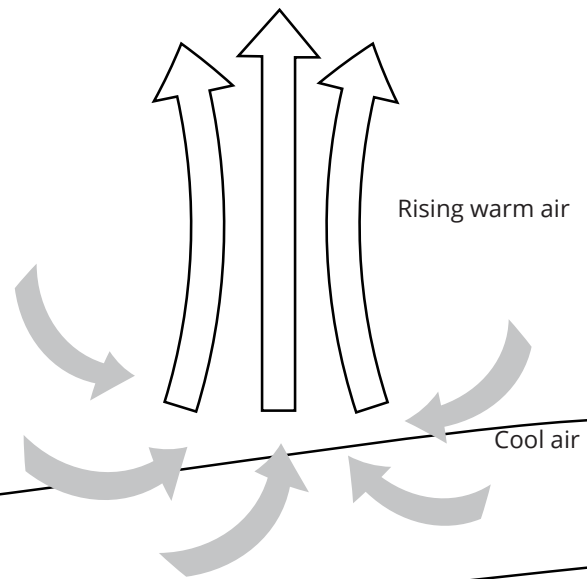

What is wind energy?

When the wind blows, it can be used to create electricity with the help of wind turbines.

A wind farm is a group of wind turbines that make electricity, which feeds into the national power system.

Wind energy is clean, renewable energy, so it doesn't harm the environment - and it's free!

Wind energy is a form of solar energy, because wind is caused by the sun warming up the earth.

Did you know?

Each turbine has its own electric 'brain'. They work automatically and turn themselves on when the breeze is blowing just right!

THE POWER OF WIND has been used for centuries for transport, industry, farming and leisure. Today, wind power is an important energy source in New Zealand and around the world. Wind farms give us another way to generate electricity, reduce fossil fuels and protect our hydro supplies. Wind turbines work in a very simple way: when the wind blows, the

blades turn, which turn a generator inside the turbine that makes electricity. This electricity is sent to a power station, which sends out the electricity to your home! Modern wind turbines are much larger and very efficient. Today's average-sized wind farm can produce as much renewable energy as a medium-sized hydro power station.

Inside a Wind turbine

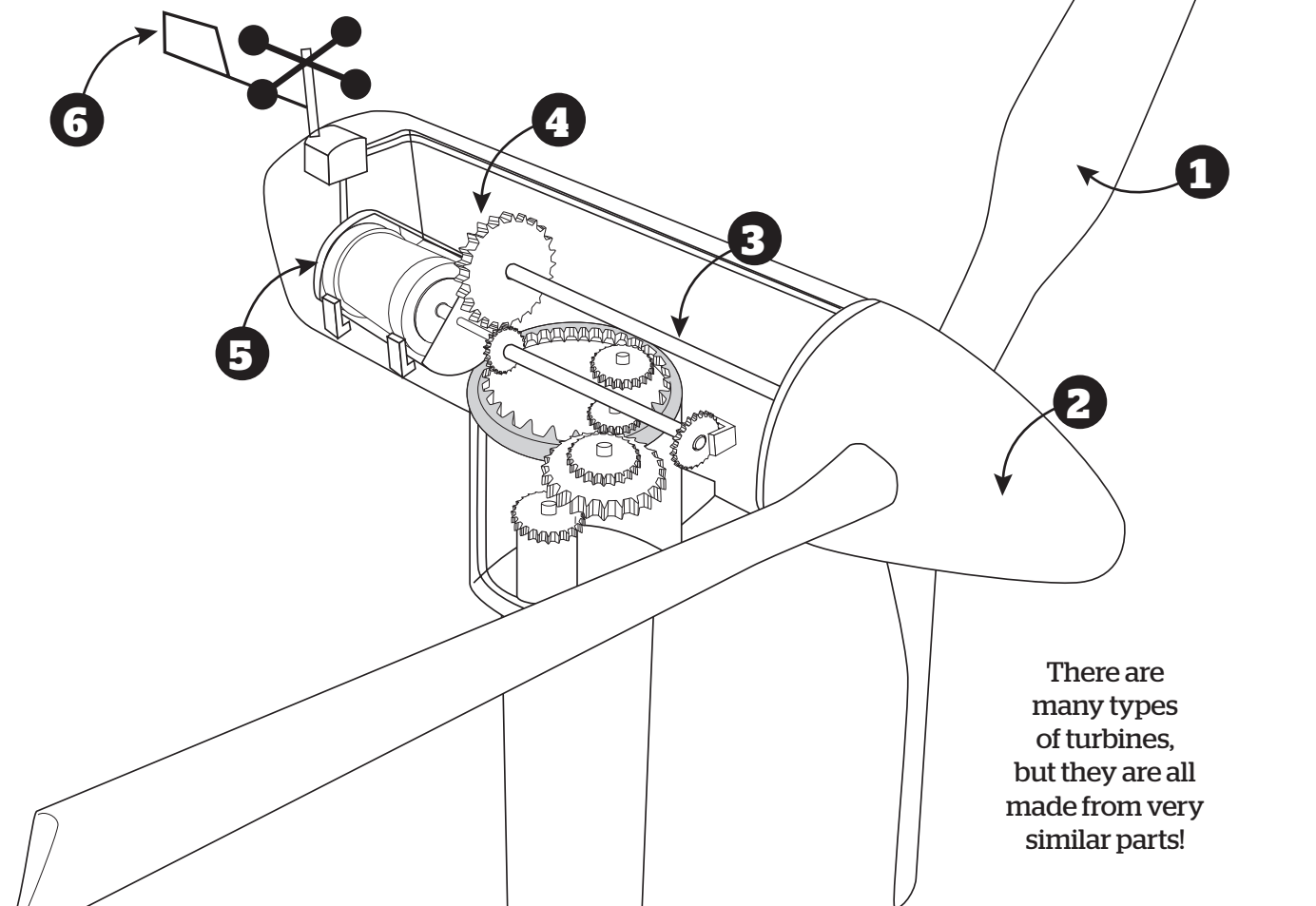

There are many types of turbines, but they are all made from very similar parts!

Let's take a look inside

- 1** The **blade** turns in the hub and can adjust to the different wind speeds.
- 2** The **hub** connects the blades to the main tower.
- 3** The **main section** turns with the blades and hub and takes the power to the gearbox.
- 4** The **gearbox** takes the slow rotation of the main section and increases the speed for the generator up to 90 times.
- 5** The **generator** takes the mechanical energy from the rotating section and converts it into electrical energy.
- 6** **Weather instruments** include a wind vane to sense the wind direction. This helps the turbine to face into the wind.



Did you know?
Most turbines change direction as the wind changes so they can "catch" the wind!

From the Turbine to your toaster

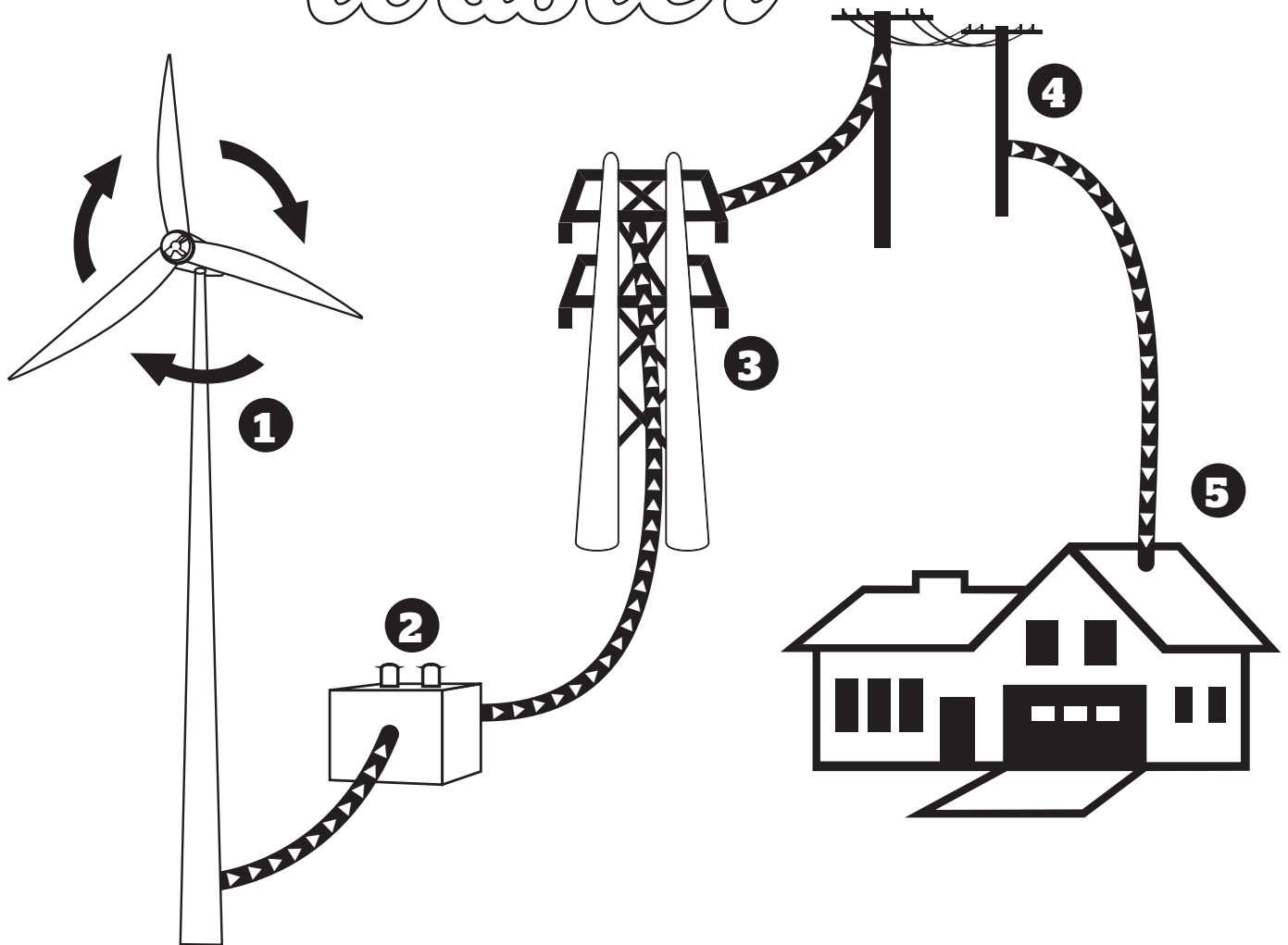

How does wind electricity get to your home?

Let's see how it travels:

- 1** The wind turbine makes electricity.
- 2** The electricity is sent to a transformer.
- 3** The transformer sends the electricity to the power station, which sends it out through a transmission line.
- 4** The transmission line sends out the electricity to overhead power lines.
- 5** The power lines send the electricity to your home; you use this electricity for everything that needs power, such as lights, computers, refrigerator, fans, and even your toaster!

Did you know?

Wind Turbines are a good way to make electricity because they produce no pollution!

Wind Word Power

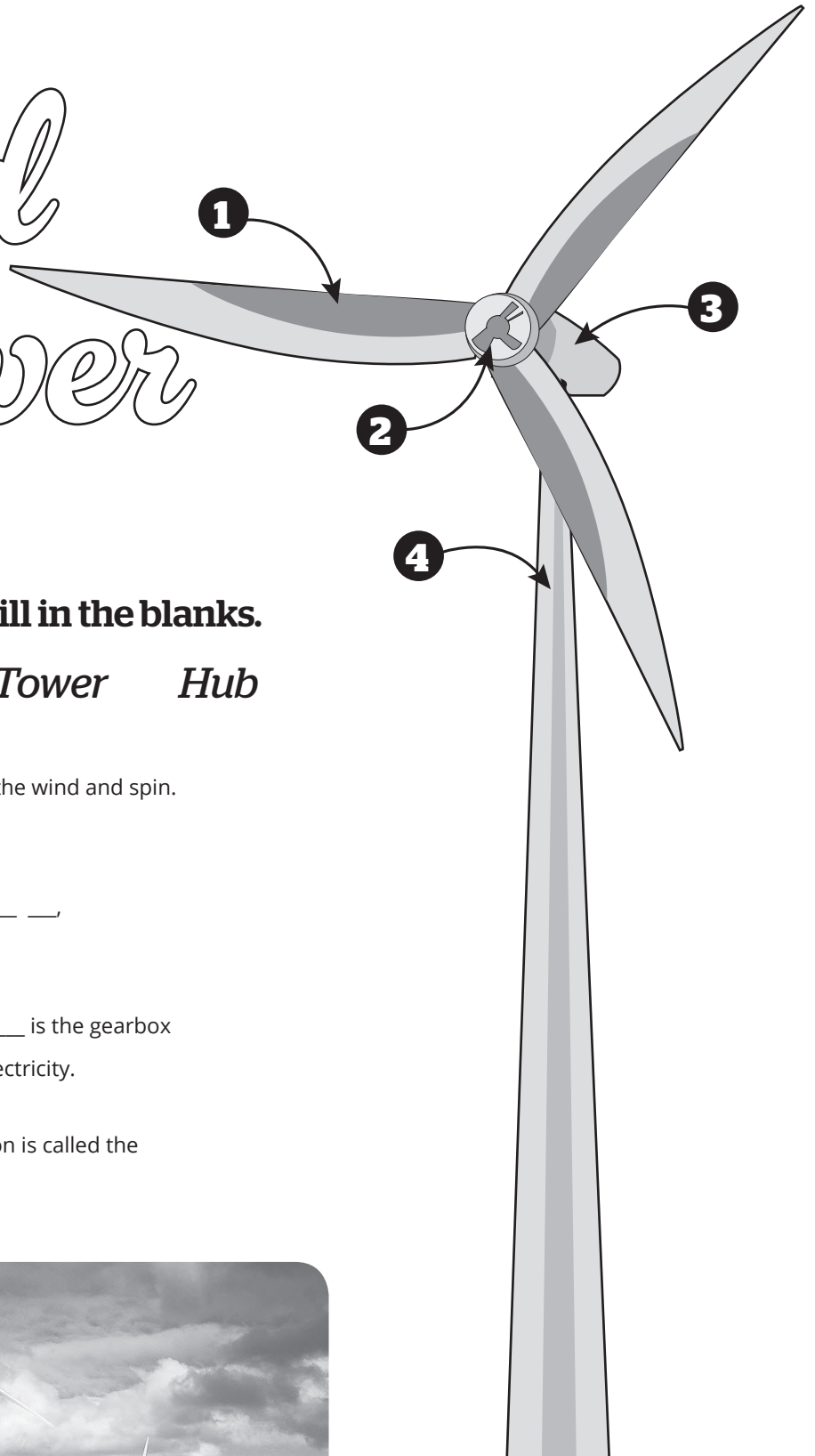

Use the words below to fill in the blanks.

Nacelle Blades Tower Hub

- 1 The _____ catch the wind and spin.
There are three of these.
- 2 The blades are joined to the _____
which moves round and round.
- 3 Inside the _____ is the gearbox
and generator, which make the electricity.
- 4 The tall structure the turbine sits on is called the
_____.



Did you know?

A wind farm is many turbines grouped together. Most wind farms in New Zealand are used to farm cows and sheep, too!

Colour in the Wind Farm

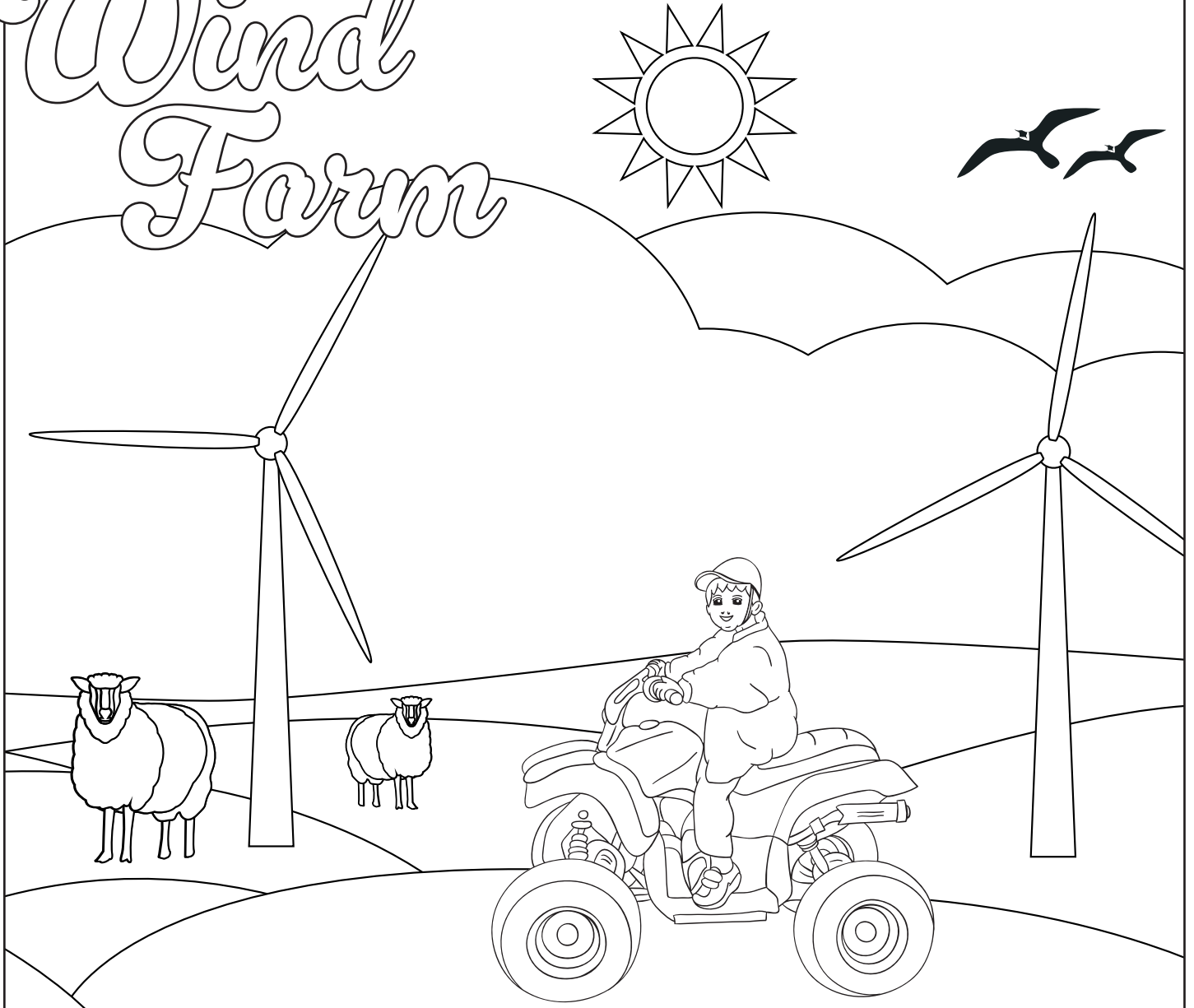

How many words can you find?

w z a t e n e r g y
 h r e u m a i h s w
 i x d r v c o u t i
 h u b b r e z s m n
 h y l i n l n e n d
 q f o n b l a d e s
 p o w e r e y h t r

nacelle
 wind
 blow
 energy
 blades
 hub
 turbine
 power

Make a simple Anemometer

An anemometer measures how fast the wind is blowing. Here's how to make your own:

- 1** Tape each end of the straw to the back of each cup, on opposite sides of the straw.
- 2** Use a thumb tack to attach the straw to the pencil eraser at the middle.
- 3** Take it outside and watch it spin in the wind.

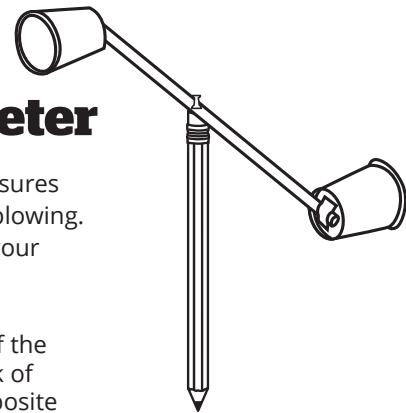

You will need:
 1 straw
 1 thumbtack
 1 pencil
 2 small paper cups
 Sellotape

Make a Pinwheel

**Give it a blow,
watch it go!**

Make it Meridian –
cut out and attach
to the centre of your
pinwheel!

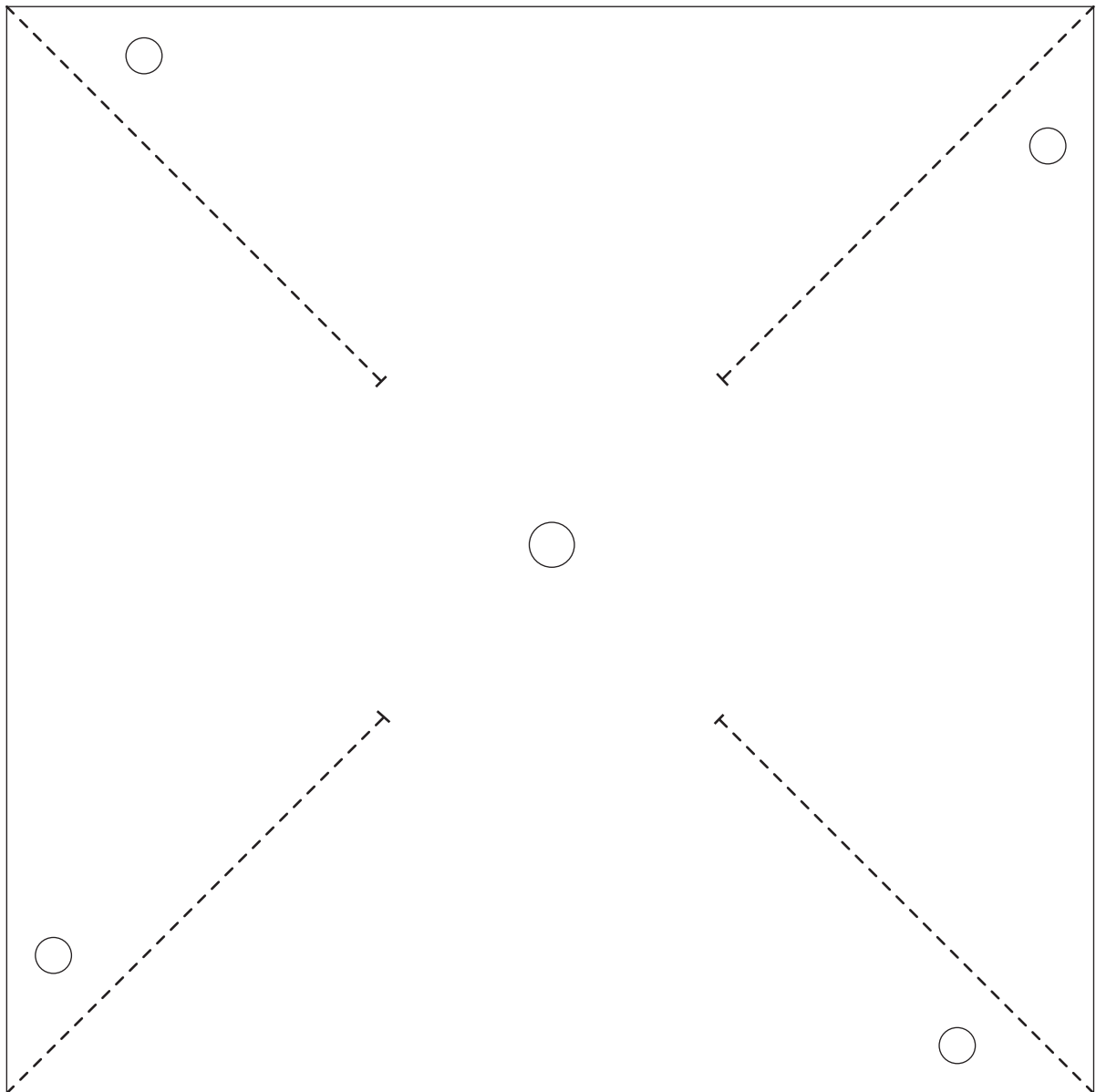
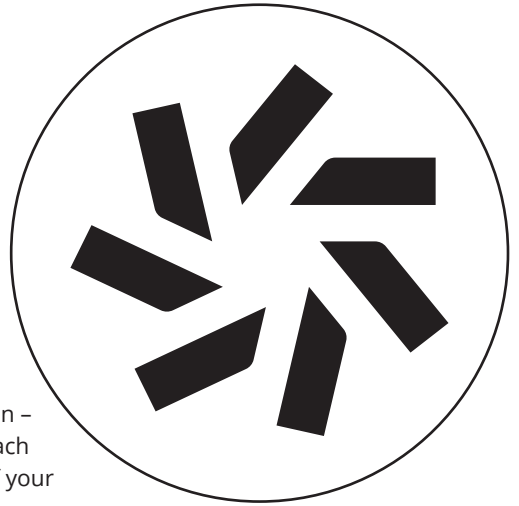

- 1** Cut out the square above, and cut along each of the dotted lines. Be careful not to cut all the way to the middle!
- 2** Punch out the holes, and flip the side holes to the centre hole.
- 3** Push a thumbtack through the holes, and onto a pencil eraser.
- 4** Blow straight into the pinwheel and watch it go!

***Pinwheels work just like wind
turbines: they need wind to move!***

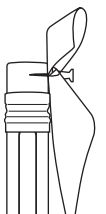
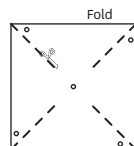



Meridian.

Level 2, Quad 7
6 Leonard Isitt Drive
Auckland Airport
Auckland 2022

33 Customhouse Quay
PO Box 10840
Wellington 6143
Tel 04 381 1200

287/293 Durham Street North
Christchurch Central
Christchurch 8013

State Highway 8
Private Bag 950
Twizel 7944
Tel 03 435 9393